

# KOLI C-3

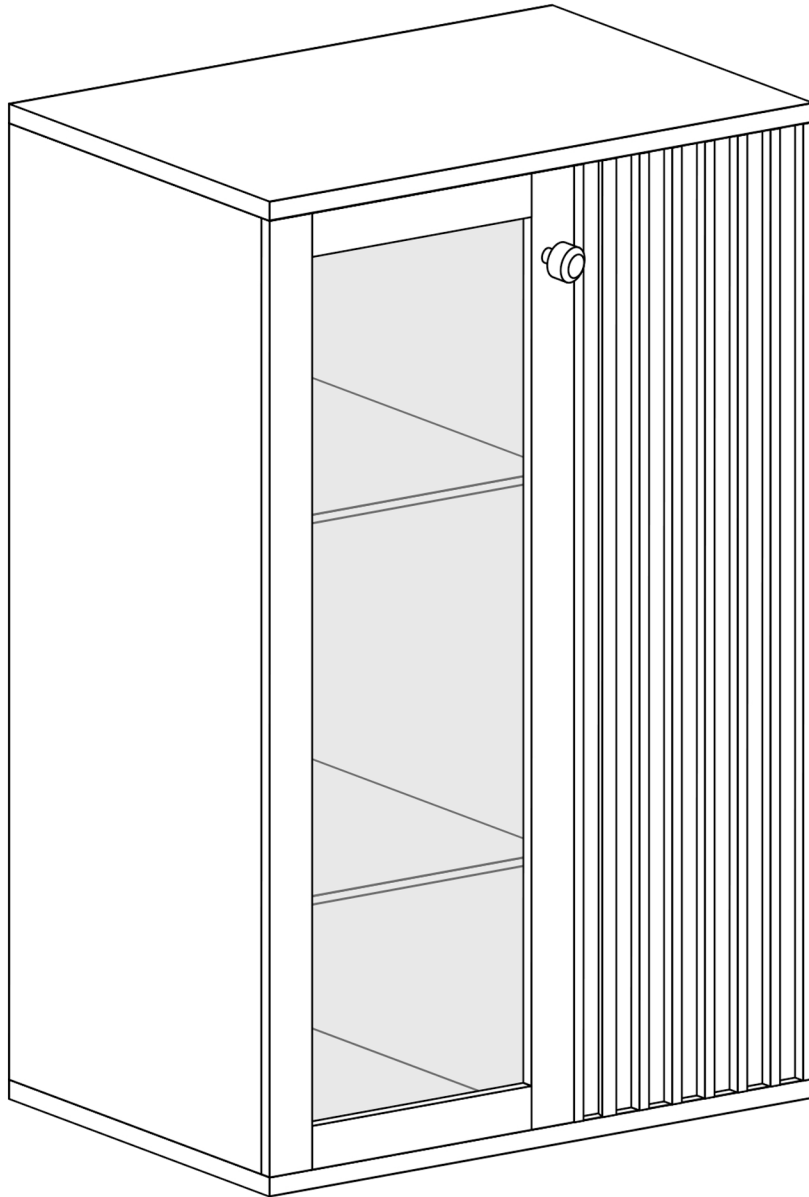

1	1245	386	16	1
2	1245	370	16	1
3	864	406	32	1
4	864	406	32	1
5	1245	386	16	1
6	452	370	16	2
7	342	370	16	2
8	1285	364	2,5	1
9	1285	472	2,5	1
10	1239	483	16	1
11	1239	356	32	1

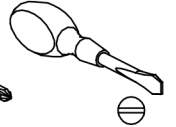
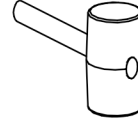
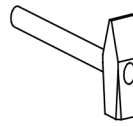
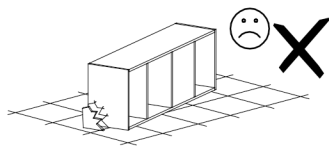
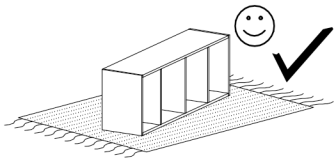
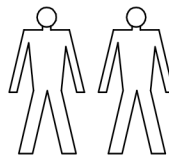

**X1 - 12**

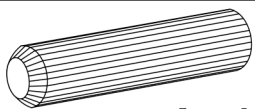

**A - 12**

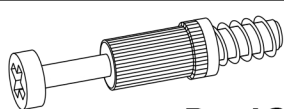

**B - 12**



**C - 12**

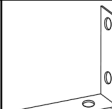

**Y1 - 1**

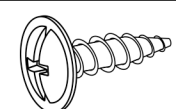

**Y2 - 2**  
3,5x16

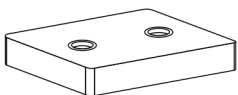

**D - 5**

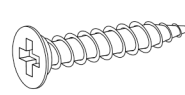

**E - 10**  
3,5x25

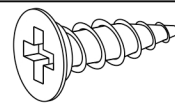

**F - 21**  
3,5x16

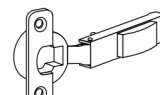

**I - 6**



**J - 6**

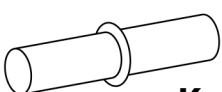

**K - 16**

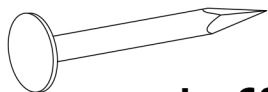

**L - 60**

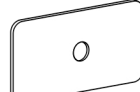

**M - 9**



**N - 1**

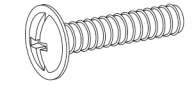

**O - 1**  
3,5x20

I

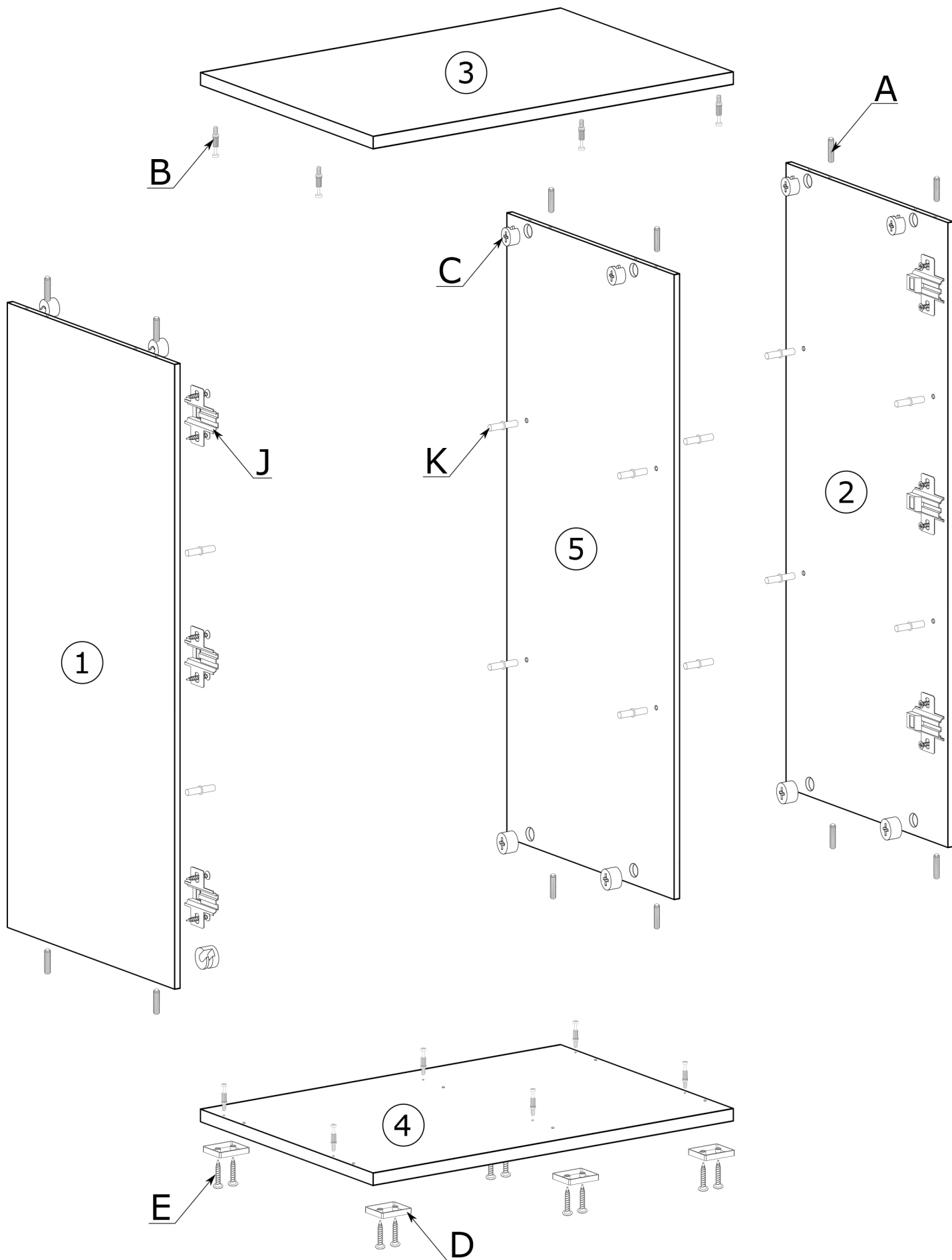

II

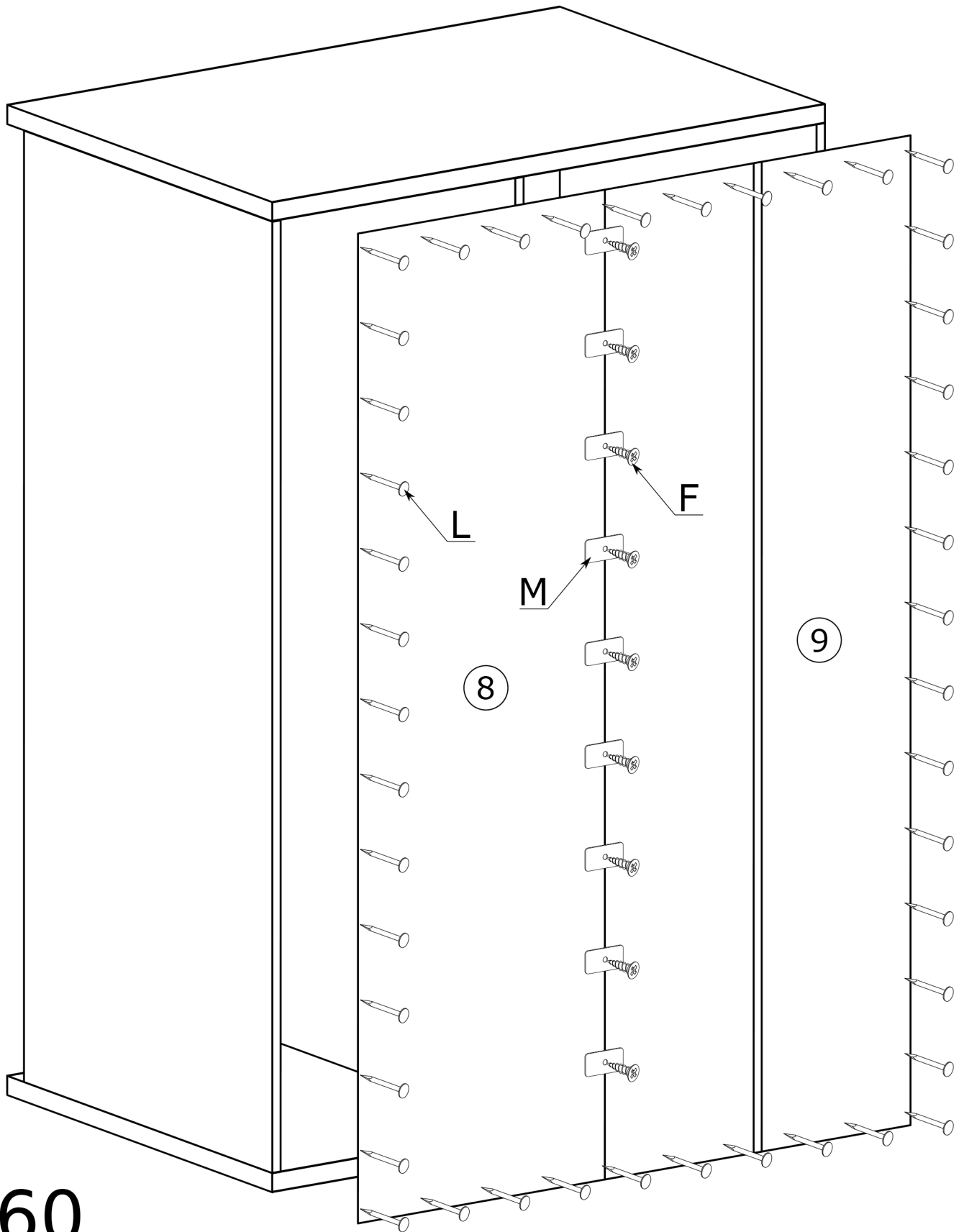

x60

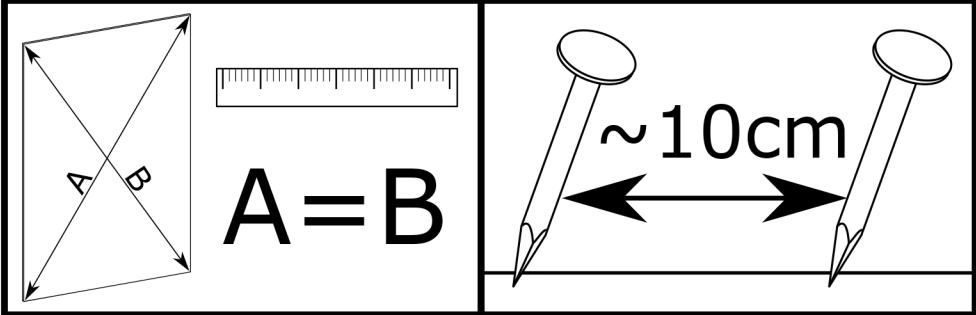

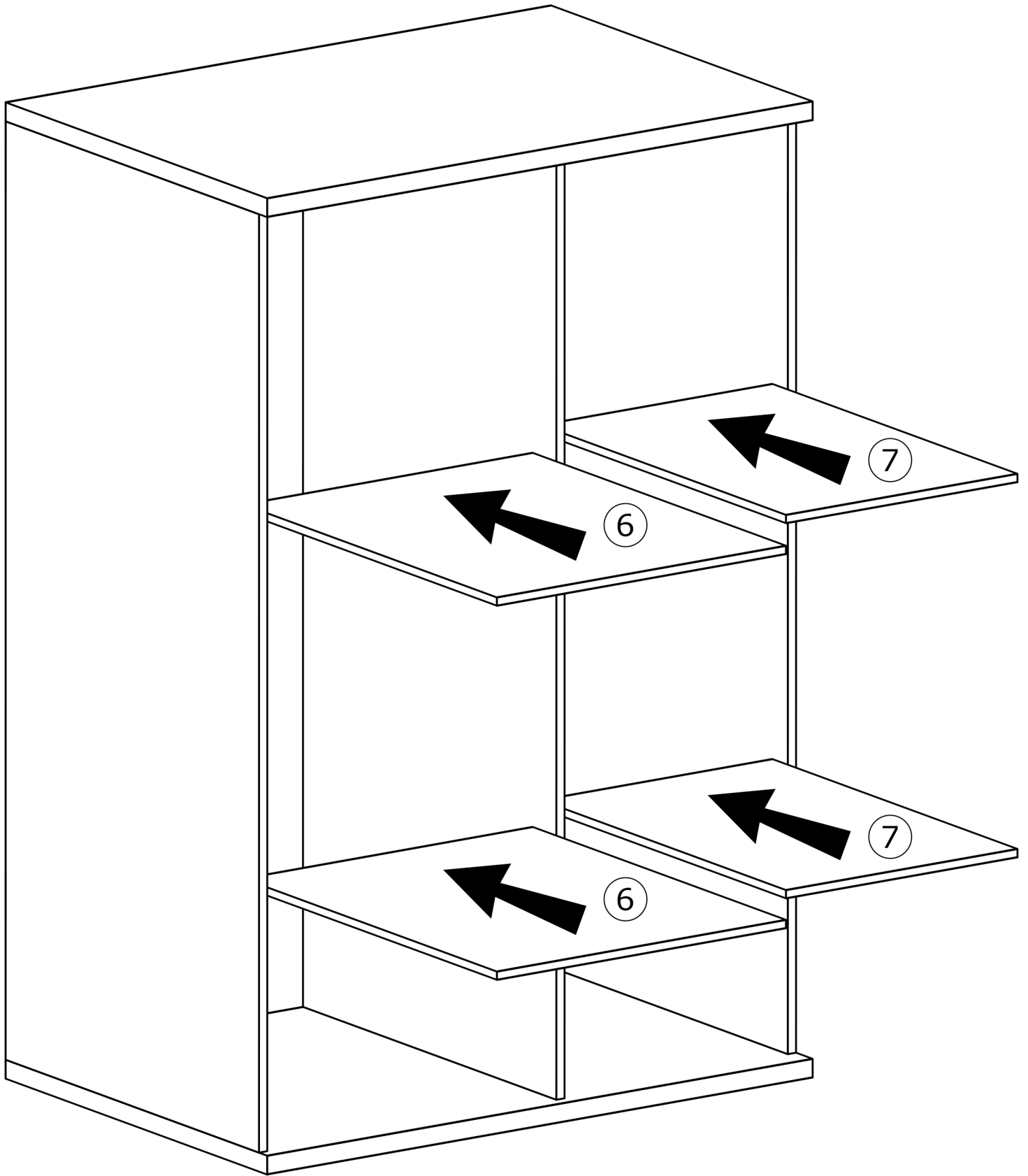

IV

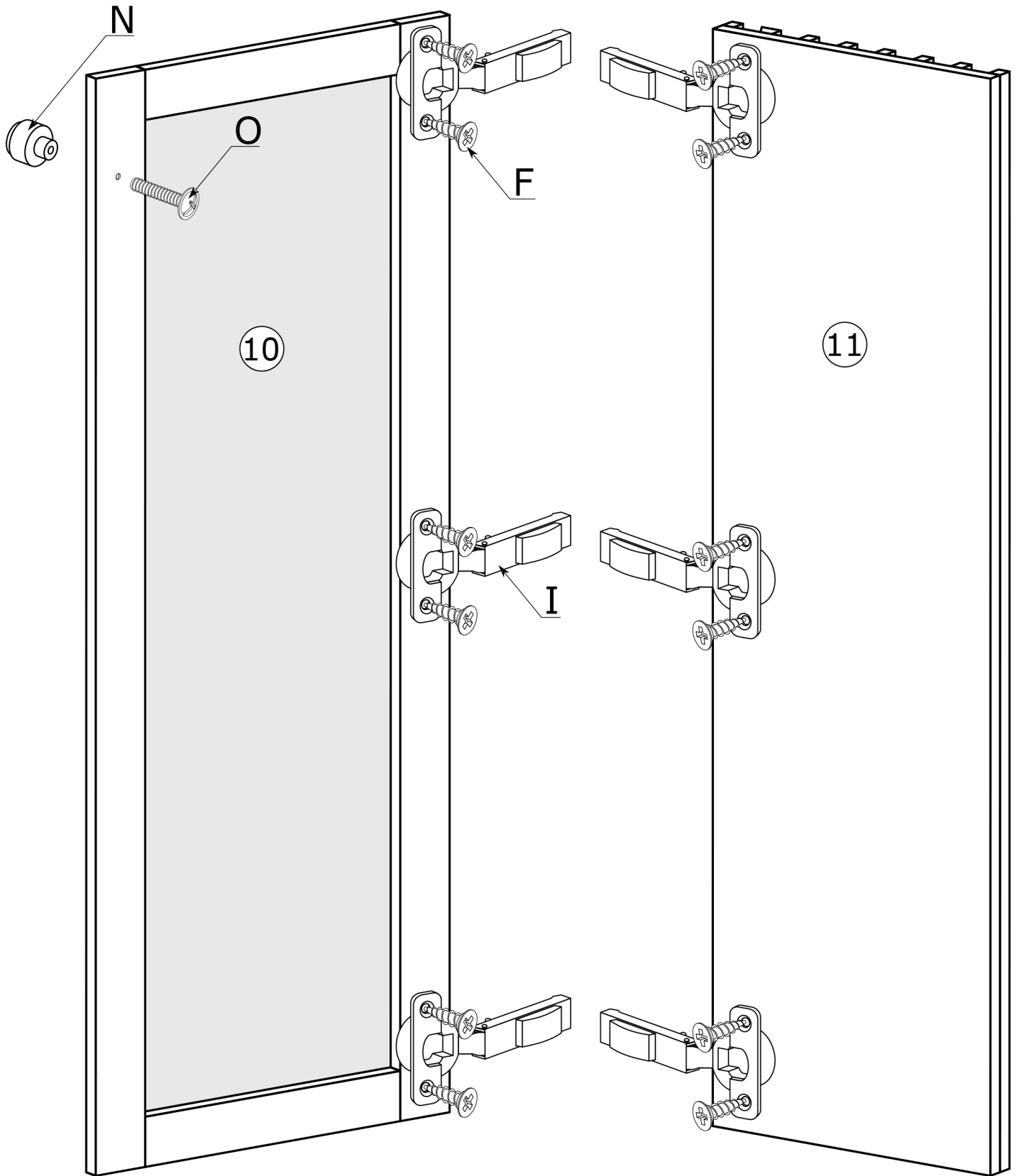

V

